

Clarke®



PUDDLE PUMP
MODEL NO: PSP195
PART NO: 7239240

**OPERATION & MAINTENANCE
INSTRUCTIONS**



ORIGINAL INSTRUCTIONS

GC0819 - ISS 1

INTRODUCTION

Thank you for purchasing this CLARKE Puddle Pump. The pump is of the submersible type, designed for domestic use, with manual or automatic operation. It is suitable for drying out basements subject to flooding and for pumping drainage wells or rainwater collecting traps.

Due to its compact shape, it can be used as a portable pump for emergency situations such as for drawing water from tanks or rivers, draining swimming pools and fountains, excavations or underpasses. Also suitable for gardening and general hobby activity.

This pump should not be used in swimming pools, ponds or hot tubs where people are present, or for pumping hydrocarbons (petrol, diesel fuel, combustible oils, solvents, etc.) in accordance with the accident-prevention regulations in force.

It is not designed for continuous use, but over a limited period and should be cleaned before putting away in storage. See the section "Maintenance".

GUARANTEE

This product is guaranteed against faulty manufacture for a period of 12 months from the date of purchase. Please keep your receipt which will be required as proof of purchase.

This guarantee is invalid if the product is found to have been abused or tampered with in any way, or not used for the purpose for which it was intended.

Faulty goods should be returned to their place of purchase, no product can be returned to us without prior permission. This guarantee does not effect your statutory rights.

ENVIRONMENTAL RECYCLING POLICY



Through purchase of this product, the customer is taking on the obligation to deal with the WEEE in accordance with the WEEE regulations in relation to the treatment, recycling & recovery and environmentally sound disposal of the WEEE.

In effect, this means that this product must not be disposed of with general household waste. It must be disposed of according to the laws governing Waste Electrical and Electronic Equipment (WEEE) at a recognised disposal facility.

SAFETY INSTRUCTIONS

GENERAL

1. Read all instructions before use and save these instructions for future use.
2. An approved residual current device (RCD) which has a tripping current of less than 30mA **MUST** be used for all operations.
3. The electrical supply must be the same as that on the rating plate.
4. Always make sure that your hands are dry when connecting or disconnecting from the mains supply.
5. Never pull the mains lead to disconnect the pump from the mains socket.
6. The mains plug must be kept away from the water at all times.
7. Do not allow children or unauthorised people to touch the pump, cables or connections.
8. Disconnect the pump from the mains supply when not in use.
9. Keep the mains lead away from heat, oil and sharp edges.
10. If you have to use an extension lead with this product it must be designed for outdoor use and incorporate a cable suitable for use with Class I appliances.
11. Disconnect the pump from the electrical supply and wear gloves during servicing or maintenance.

PUMP SPECIFIC

1. Do not pump explosive / flammable liquids or chemicals.
2. Never allow the pump to run dry or operate out of the water.
3. Submersible pumps should always be submerged and stored vertically.
4. Disconnect the pump from the mains supply before placing it into or removing it from the water.
5. Always check the plug and cable for damage before use.
6. Do not use the pump if damaged. Refer to qualified service personnel for repair.
7. Never carry or lower the pump by the power cable. Always use the handle or a rope tied securely to the handle.
8. Never use the submersible pump in a swimming pool when there are people or animals in the pool.
9. Keep the pump clear of sediment by standing it on a platform or brick or suspending it at a suitable depth.
10. Do not use the pump if the water is liable to freeze, as this can cause damage to the pump. Remove the pump from the water and store it in a frost free location.

ELECTRICAL CONNECTIONS



WARNING: READ THESE ELECTRICAL SAFETY INSTRUCTIONS THOROUGHLY BEFORE CONNECTING THE PRODUCT TO THE MAINS SUPPLY.

These pumps **MUST** be fitted with a Residual Current Device (RCD), with a rated residual operating current of no greater than 30mA. This is essential when the pump is used for pumping swimming pools.

The mains lead must be connected to a standard 230 volt (50Hz) electrical supply through an approved plug or a suitably fused isolator switch.



**WARNING: THE WIRES IN THE POWER CABLE OF THIS PRODUCT ARE COLOURED IN ACCORDANCE WITH THE FOLLOWING CODE:
BLUE = NEUTRAL BROWN = LIVE YELLOW AND GREEN = EARTH**

As the colours of the flexible cable of this appliance may not correspond with the coloured markings identifying terminals in your plug proceed as follows:

- The BLUE wire must be connected to the terminal which is marked N.
- The BROWN wire must be connected to the terminal which is marked L.
- The YELLOW AND GREEN wire must be connected to the terminal which is marked E or \perp .

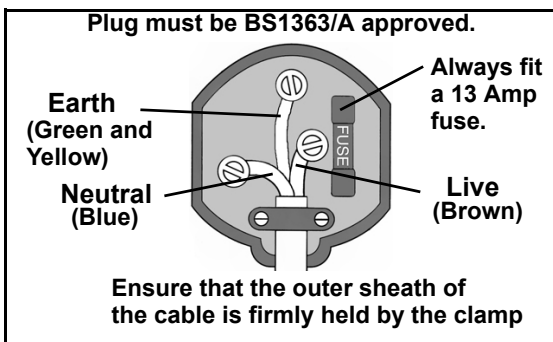

In the event that the pump is hard-wired into the electrical system, it must be carried out in accordance with IEE regulations.

INSTALLING THE PUMP



WARNING: CHECK THE PUMP FOR DAMAGE BEFORE USE AND DO NOT USE IF DAMAGED IN ANY WAY.

WARNING: THE WATER SEAL CONTAINS LUBRICANT WHICH IS NON-TOXIC BUT WHICH MAY ALTER THE CHARACTERISTICS OF THE WATER IN THE CASE OF PURE WATER, IF THE PUMP WERE TO DEVELOP ANY LEAKS.

1. Remove all packaging and make sure that the pump has no visible damage. Dispose of all packaging appropriately.
 - The stepped hose adaptor supplied is designed to be used for either screw type hose connection or push fit.
2. Connect a suitable hose (not supplied) to the adaptor.
 - Suitable hoses are available from your local Clarke dealer.
3. When push fitting the hose to the adaptor use a jubilee clip to secure it.
4. Stand the pump upright on a flat surface in the water that you want to drain.
5. Ensure the pump is positioned with adequate space - recommended minimum base area of 20 x 20 cm and the maximum depth of any installation - 7 metres. The pump is supplied with 10 metres of power cable.
6. Always raise and lower the pump using the lifting handle and a rope attached to it if required. Never lift or lower the pump using the power cable.
 - The filter base inlet must be fully submerged before the pump is switched on and the pump is standing vertical.
7. Connect the mains plug to the mains supply via a high sensitivity residual current device (RCD) which has a tripping current of less than 30mA.
8. Switch the mains power supply on.

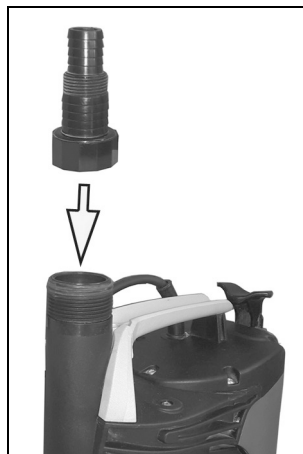

OPERATION

To operate the pump move the tab to the required position for either Auto or Manual mode.

AUTOMATIC OPERATION (A)

To set the pump running automatically:

1. Move the tab until the indicator is positioned on "A" (automatic).
 - When the float reaches the ON level the pump will start and will continue operating until the float drops to the OFF level.

MANUAL OPERATION (M)

To manually start the pump:

1. Lift the tab until the indicator is positioned on "M" (manual).
 - The pump will run indefinitely.
2. When the water level is down to 2-3 mm disconnect the pump from the mains power supply..

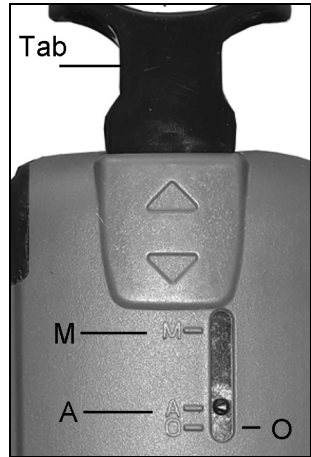

CAUTION: DO NOT ALLOW THE PUMP TO RUN DRY

The pump is fitted with a thermal overload switch. If the pump overheats for any reason, it will automatically switch OFF. Once the pump has cooled (at least 5-10 minutes), it will automatically restart.

AFTER USE

If the temperature is lower than 0°C, ensure there is no residual water in the pump which could freeze, causing cracks in the plastic parts.

If the pump has been used with substances that tend to form a deposit, or with water containing chlorine, rinse it after use with a powerful jet of water in order to avoid the formation of deposits which would reduce the performance of the pump.

MAINTENANCE



WARNING: BEFORE CHECKING THE CONDITION OF THE PUMP, ENSURE IT IS UNPLUGGED FROM THE MAINS SUPPLY. IF THE UNIT IS HARD WIRED, ENSURE THE CIRCUIT BREAKER IS OPEN.

This pump should require no maintenance other than regular cleaning. If the pump shows signs of wear or damage contact your CLARKE dealer for advice.

CLEANING

1. Check the pump regularly to ensure the water inlet is clear of leaves or other debris. If foreign material has been drawn into the pump inlet, further cleaning may be required.

CLEANING THE FILTER BASE AND IMPELLER

1. Switch off the power supply to the pump.
2. Remove the retaining screws securing the filter base and lift the base away.
3. Clean the impeller and check that it can spin freely.
4. Re-fit the filter base.

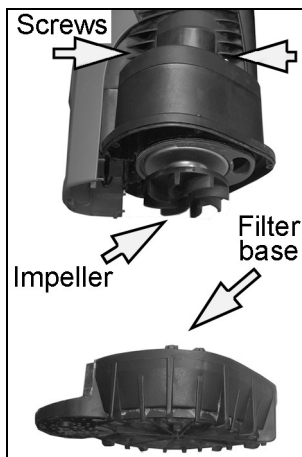

CLEANING THE FLOAT SWITCH

1. If a collection of foreign material is impeding the movement of the float switch it may be necessary to clean it.
2. Position the control tab at "0" and unclip the cover by pulling it away from the pump body.
3. Remove any foreign material that prevents the free movement of the float.
4. Re-fit the cover.

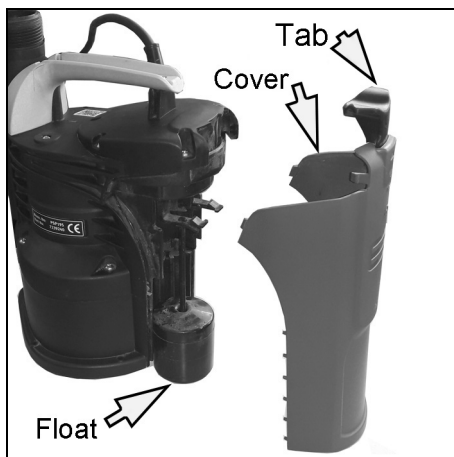

TROUBLESHOOTING

| PROBLEM | SOLUTION |
|------------------------------|---|
| PUMP WILL NOT START | <ol style="list-style-type: none"> 1. Make sure that the power is switched on. 2. Check fuse (consult an electrician if in doubt). 3. If extension lead is used, check connections (consult an electrician if in doubt). 4. Internal thermal cut-out has not re-set. Leave for 5-10 minutes and try again. 5. The impeller may be jammed. Disconnect from the mains supply and remove any objects that may be obstructing the impeller. 6. Float switch may be jammed or prevented from moving. 7. Water level too low - float switch in OFF position - lift float to check switch. 8. If the pump still fails to start, consult your CLARKE dealer for advice. |
| PUMP WILL START BUT NOT PUMP | <ol style="list-style-type: none"> 1. Check that the inlet is not blocked. 2. Check that the discharge tube is not clogged or obstructed. 3. The head may be too great, i.e. you are trying to lift the water too great a distance for the pump to cope with. ("It is not designed for continuous use, but over a limited period and should be cleaned before putting away in storage. See the section "Maintenance"." on page 2). 4. Air bubble in the pump, produced during the plunge. Plunge the pump again, at an angle, and shake it whilst lowering to remove any air trapped in the system. 5. Impeller may be damaged - Consult your CLARKE dealer. |
| PUMP WILL NOT STOP | <ol style="list-style-type: none"> 1. Float switch may be prevented from moving to the fully down position. 2. Float switch may be faulty. Consult your CLARKE dealer for advice. |
| PUMP STOPS RUNNING | <ol style="list-style-type: none"> 1. Thermal overload has operated. Leave for 5-10 minutes and try again. 2. Pump has run dry or float switch has cut in. 3. A foreign object has jammed the impeller. |

If this does not solve your problem, please contact the CLARKE service department. Do not attempt to repair the pump yourself. Repairs must be carried out by your CLARKE dealer.

PARTS DIAGRAM

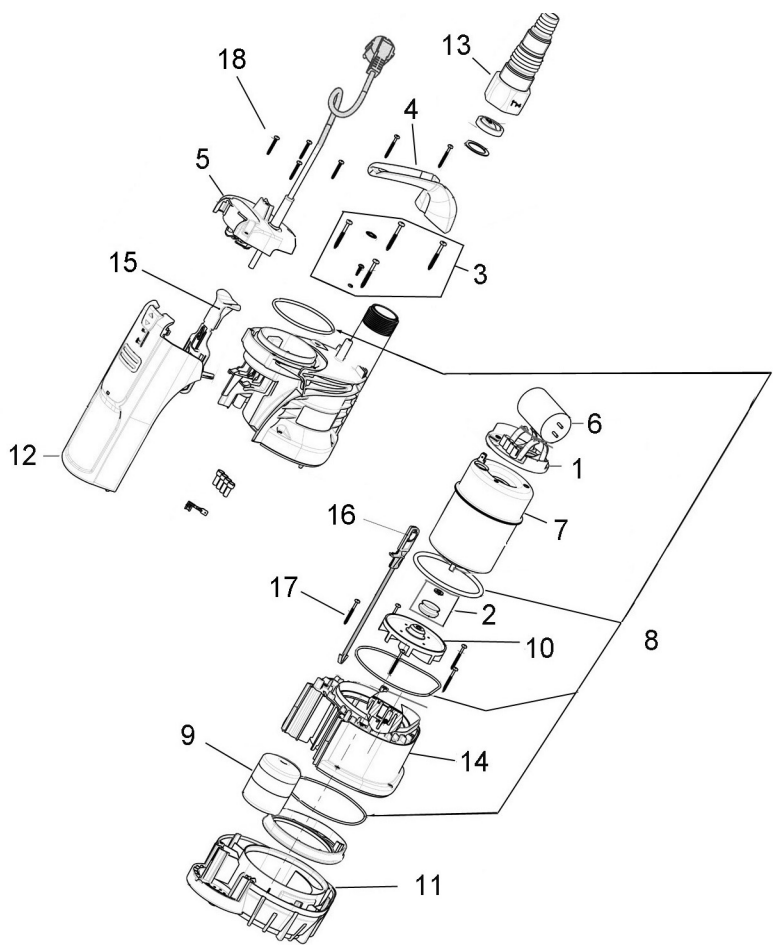

| | |
|---|------------------------------|
| 1 | Capacitor holder / connector |
| 2 | Seal kit |
| 3 | Motor screws & o-rings |
| 4 | Handle c/w screws |
| 5 | Cover unit with power cable |
| 6 | Capacitor |
| 7 | Motor assembly |
| 8 | O-Ring kit |
| 9 | Floatswitch |

| | |
|----|--------------------------|
| 10 | Impeller kit |
| 11 | Filter base |
| 12 | Float switch cover |
| 13 | Stepped adaptor / O-ring |
| 14 | Pump body kit |
| 15 | Control tab |
| 16 | Float guide |
| 17 | Filter base screws |
| 18 | Cover retaining screws |

SPECIFICATIONS

| | |
|----------------------------------|----------------------------------|
| Dimensions (D x W x H) | 225 x 185 x 335 mm (exc adaptor) |
| Weight | 5.3 kg |
| Outlet Size | 32 mm dia (male 1¼ " BSP) |
| Power supply | 230v ~ 50 Hz |
| Rated power | 665 W |
| Fuse Rating in BS plug | 13 A |
| Cable length | 10 m |
| IP Rating | IP X8 |
| Maximum delivery | 195 L/min |
| Max. head | 9 m |
| Max particle size | 5 mm |
| Maximum depth | 7 m |
| Residual water depth | 2-3 mm |
| Minimum automatic starting depth | 115 mm |
| Automatic stopping depth | 45 mm |

PERFORMANCE CURVE

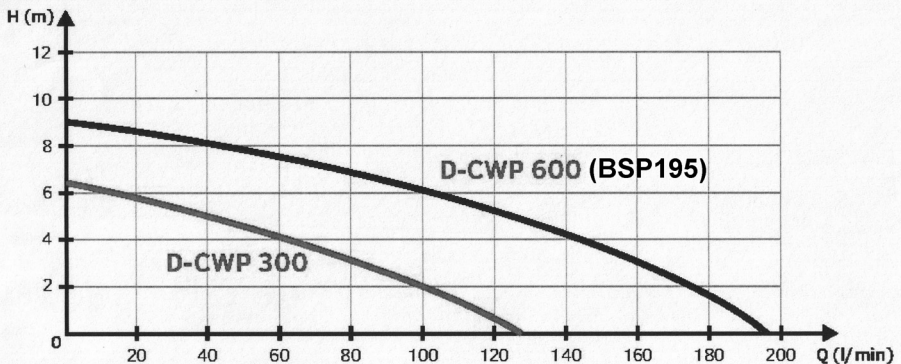

DECLARATION OF CONFORMITY



Clarke[®]
INTERNATIONAL

Hemnal Street, Epping, Essex CM16 4LG

DECLARATION OF CONFORMITY

This is an important document and should be retained.

We hereby declare that this product(s) complies with the following directive(s):

2014/30/EU *Electromagnetic Compatibility Directive.*
2014/35/EU *Low Voltage Equipment Directive.*
2011/65/EU *Restriction of Hazardous Substances.*

The following standards have been applied to the product(s):

EN 60335-2-4:2003+A2:2010, EN 60335-1:2012+A11:2014.

The technical documentation required to demonstrate that the product(s) meet(s) the requirement(s) of the aforementioned directive(s) has been compiled and is available for inspection by the relevant enforcement authorities.

The CE mark was first applied in: 2019

Product Description: Puddle Pump
Model number(s): PSP195
Serial / batch Number: N/A
Date of Issue: 31/05/2019

Signed:

J.A. Clarke
Director

A SELECTION FROM THE VAST RANGE OF

Clarke®

QUALITY PRODUCTS

AIR COMPRESSORS

From DIY to industrial, Plus air tools, spray guns and accessories.

GENERATORS

Prime duty or emergency standby for business, home and leisure.

POWER WASHERS

Hot and cold, electric and engine driven - we have what you need

WELDERS

Mig, Arc, Tig and Spot. From DIY to auto/industrial.

METALWORKING

Drills, grinders and saws for DIY and professional use.

WOODWORKING

Saws, sanders, lathes, mortisers and dust extraction.

HYDRAULICS

Cranes, body repair kits, transmission jacks for all types of workshop use.

WATER PUMPS

Submersible, electric and engine driven for DIY, agriculture and industry.

POWERTOOLS

Angle grinders, cordless drill sets, saws and sanders.

STARTERS/CHARGERS

All sizes for car and commercial use.



PARTS & SERVICE: 0208 988 7400

E-mail: Parts@clarkeinternational.com or Service@clarkeinternational.com

SALES: UK 01992 565333 or Export 00 44 (0)1992 565335

Clarke® INTERNATIONAL Hemnall Street, Epping, Essex CM16 4LG
www.clarkeinternational.com